

SUPRA HMK 102 B
SERIES HMK 102 S
BACKHOE LOADER



HIDROMEK®

WITH **SUPRA** HIGH DURABILITY
HIGH COMFORT
HIGH PERFORMANCE



SUPRA

RESPONSE OF YOUR EXPECTATIONS SUPRA SERIES.

A machine that answers for every drop of fuel that you fill into your tank and provides the highest amount of work and excavation . . .

Comfort and performance under the toughest conditions . . .

High efficiency for the operator even in the longest working hours . . .

DESIGNED FOR INTENSE USE.

Excavation work on the toughest grounds, tons of sand, gravel, debris and long working hours . . .

Loading works, channel excavation or crushing works . . .

SUPRA Series backhoe loaders overcome every work that you encounter. They provide comfortable working environment and as easy use as possible in tough and long working hours for you.

With SUPRA Series, your machine stays on work longer and spends less time for maintenance and repair, thus you increase efficiency.

* Specifications and equipment may vary depending on packages.



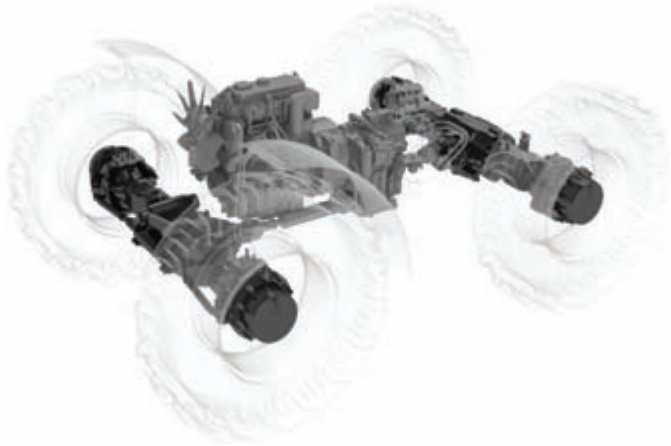

Engine

The SUPRA Series engine is one of the most economical and durable in its class. The turbocharged, 4.400 cm³ engine maintains high torque even at low rpms.

6-Forward 3-Reverse Fully-Automatic Transmission

6-forward 3-reverse fully automatic transmission used in the Supra Series allows smooth driving. The standart torque convertor lock (lock-up) provides fuel economy which is automatically engaged in the 5th and 6th gear.

MSS (Motion Stabilization System)

The standart MSS (Motion Stabilizer System) works as a shock absorber on the loader lift cylinders. By damping the shock that occurs when a full loader bucket is used on rough terrain, it provides a comfortable ride that is not only smooth but also fast as well.

Heavy-Duty Type Axles

Heavy-Duty Type Axles have been used in the SUPRA Series in scope of both load carriage and durability.

HIGH EFFICIENCY, SMART CHOICE!

Load Sensitive Piston Type Hydraulic Pump / Flowshare

The standart piston type hydraulic pump provides load sensitive hydraulic power as much as the operator needs with precise control independently from the amount of the load and engine rpm. It works with efficiency up to %95.

As a standart equipment, FLOWSHARING valves provides excellent hydraulic control independently from the amount of the load and operator's skills for various field works such as pipe lying and channel trenching.

It allows simultaneous boom, arm and bucket motions even in the low rpms and provides the opportunity of working in noise restricted areas such as hospital, school and city center.

Flow Charging Valves

Flow charging valves with extra regeneration feature applied on the boom and arm lines provide more efficient hydraulic power and prevent cavitation.

LSD: Limited-Slip Differential and Differential Lock

The highest traction force is provided with LSD (limited slip differential) acting on front axle and differential lock on rear axle to prevent skidding on stone gravel, mud or icy surfaces. Thus, period of tire replacement, work cycle and fuel efficiency have been improved.

MORE SPACIOUS, MORE COMFORTABLE...



CABIN INTERIOR

- Opera Control System
- Air Suspension Seat
- Adjustable Steering Wheel
- Pool Type Mats
- Detachable Lids
- Cool-Box
- Advanced Heating and Cooling System (A/C)
- Roof Shelf
- Ergonomic and Aesthetic Crusher Pedal
- Monolithic Rear Window
- Hydraulic Boom Lock
- Cabin Construction with FOPS and ROPS Certificate





SUPRA

HIDROMEK

02

HIDROMEK

HIDROMEK

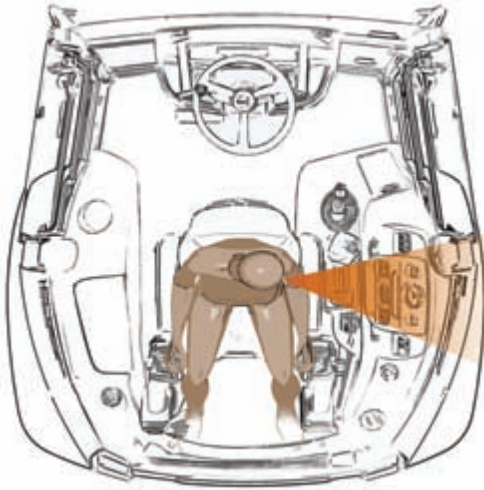

Conventional Excavation Position

In conventional backhoe loader cabins, while the operator is controlling the machine in the excavation position, he has to turn his head by 90° to the left side in order to check the gauges.

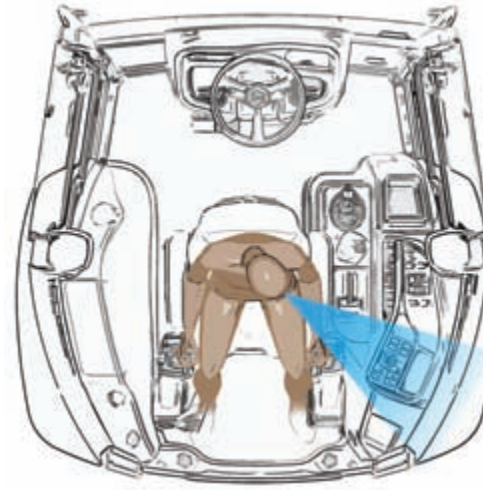

SUPRA Excavating Position

In SUPRA Series, operator may easily check the gauges through coloured TFT screen put on the rear area while he is in the excavation position. This working position allows operator to work for longer periods without suffering from neck and back aches.



Conventional Loading Position

In conventional backhoe loader cabins, while the operator is controlling the machine in the loading position, he has to turn his head by 90° to the right side in order to check the gauges.

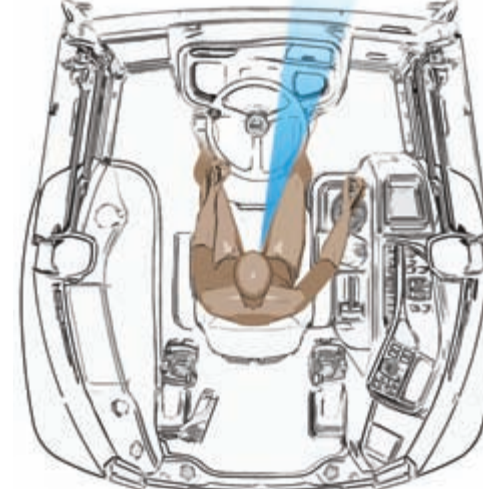

SUPRA Loading Position

In SUPRA Series, operator may easily check the gauges through LCD screen put on the front area while he is sitting in the loading position. Thus, the operator may easily check the gauges without taking his eyes off the driving direction. This working position allows operator to work for longer periods without suffering from neck and back aches.



Opera Control Schematic

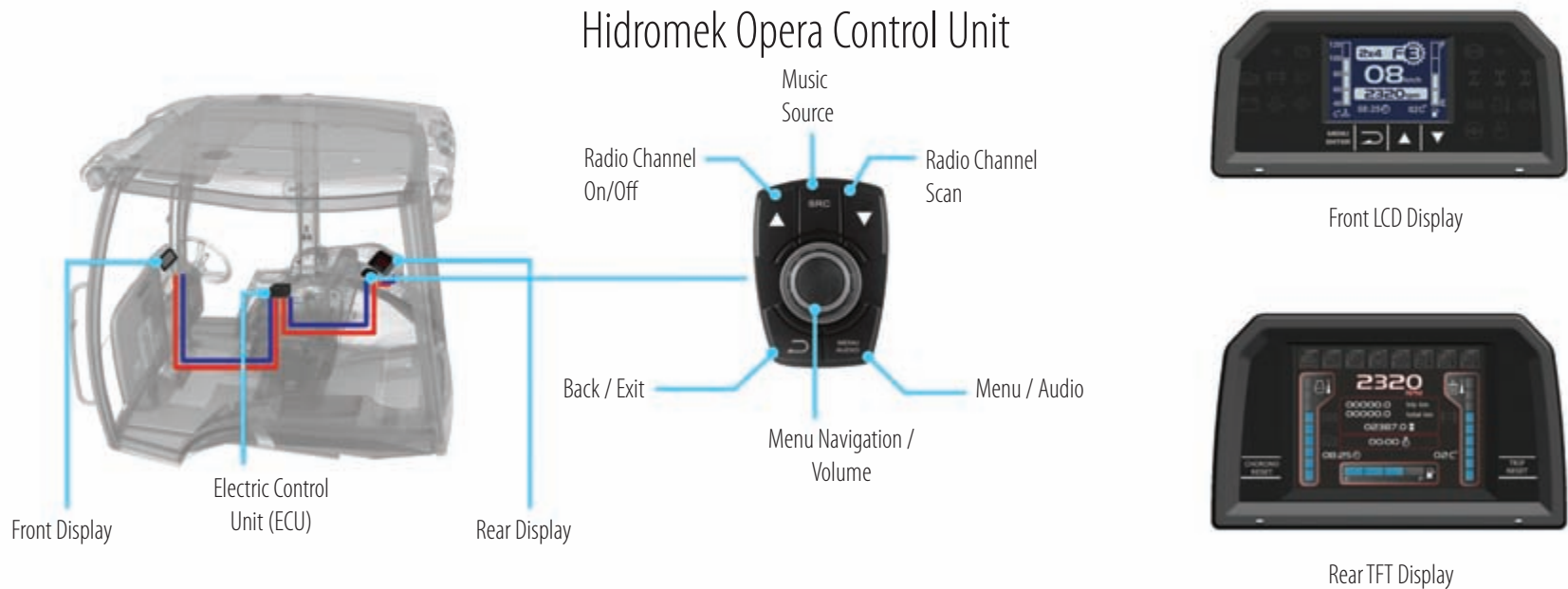

Hidromek Opera is an interface that eases the interaction between operator and machine. Hidromek Opera consists of 4 main parts. These are: two information screen, one electric control unit and one Opera Control Unit. Operator may reach all information and warnings about the machine through the LCD screen asymmetrically located on the front panel while he is working on loader position. With its unique asymmetric design, LCD screen both increase the field of view of the operator during loading and steering wheel does not block the display panel in any position. Thus, information and warnings on the display screen may always be easily seen and controlled.

In the excavation position, again all information and warnings may be reached through the coloured TFT screen located on the rear panel. Opera control unit has been situated in front of TFT screen. Operator may navigate in the menus, control the condition of machine, change the settings and control the music system with the Opera. Rear display information screen and Hidromek Opera control unit have been situated in the excavation position by prioritising operator safety. In this way, it has been prevented that the operator loses his attention.



LEAVE TOUGH WORKS TO SUPRA!

SUPRA Series for the toughest working conditions

One of the characteristics that makes the SUPRA Series different is the superior performance of the front loader. Thanks to the bucket and arm breakout force of SUPRA Series, the machine drive the load without being stressed. Boom construction intended for heavy conditions has been designed for durability for long years. 6-in-1 loading bucket (1,1 m³ in B Series – 1,2 m³ in S Series) provides advanced level of loading performance. Thanks to the bucket geometry that is designed carefully, effective use of bucket capacity is obtained. Settling blade that has been fixed with bolted system may be used double-sided by easy exchange by the operator and without the need of service. Hinged joint on the cylinders of claw opening and closing prevents damages on the cylinders when lateral loads are exposed to during driving the load. Thanks to the proportional control button on the front control lever, easy use is provided to the operator, claw speed and angle can easily be adjusted.

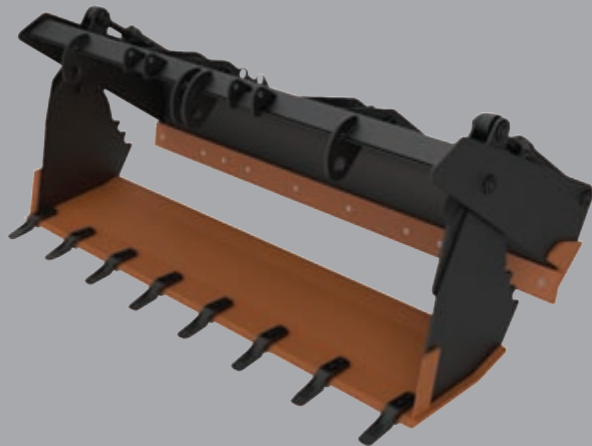

TIPSHIFT (Forward-Reverse Direction Control)

Forward-reverse direction control on front loader control lever **TIPSHIFT** allows operator to make quicker manoeuvre during loading operation. It is provided so that the operator can make these controls easily and concentrate on loading process better.

In conventional loading works and manoeuvrability in limited spaces, the operator apply both loader and forward-reverse commands from a single point without losing steering wheel handling by using the **TIPSHIFT** button.

It provides occupational safety and comfort that operator uses it without breaking the contact with steering wheel and loader controller.

All these fine details and innovations have been thought for you to make saving on time and operation costs.





Excavation, Removing or Crushing Works. . .

SUPRA Series excavator group provided and designed for tough geographical and heavy working conditions increases the productivity with its solid construction efficient hydraulic system that provides maximum breakout force even in the low rpms and that has maximum 163 lt. /min oil flow.

Rear joysticks that are standard in SUPRA models allow for easy control in the works such as lifting and lowering that require precision for operators. Joystick consoles that may be adjusted independently from each other provide ergonomic working environment.

Long hours of excavation works become pleasure with SUPRA Series that has wide visibility and ergonomic working environment.

SUPRA Series that has excellent weight distribution and wide stabilizers provides safer excavation opportunity in sloppy lands. Additional hydraulic line that is maintained as standard kit for crusher and attachment use does not prevent visibility during excavation and is not damaged in deep excavations.

Cushioning system in the excavation cylinder softens the movements at the ends of strokes, absorbs the impacts and prolongs the machine life. Telescopic arm that has digging depth up to 5.80 m. provides an advantage in deep excavations and the works that require long reach.

What can be more enjoyable than a work running without any problem?





ADJUSTABLE STEERING WHEEL

Ergonomically designed, adjustable steering wheel enables the operator to work during long lasting hours and to control the machine easily without conceding comfort.



AIR SUSPENSION SEAT

Owing to the characteristics that allow up-down and forward-backward oscillation, with automatic weight adjustment and back support, it provides high comfort and efficient working conditions for long hours.



FRONT LOADER CONTROL LEVER

4 basic functions being used while working in loading position have been gathered on the front control lever. **TIPSHIFT** providing forward-reverse manoeuvre control of the machine, kickdown button to downshifting, RTD (Automatic Return to Dig Button) and claw opening and closing propotional button provide handling from a single point and ease of use.



BACKHOE JOYSTICK CONTROL

An ideal working environment is generated with the backhoe joysticks that are provided as standard kit in the SUPRA Series backhoe loaders and can be adjusted ergonomically.





ISO PATTERNSHIFTER

Controls of joysticks provide the opportunity to use in both SAE and ISO standards with the controller shifter button by consideration of operator habits.



LED WORKING LIGHTS

Long-lasting LED working lights that use less energy compared to conventional lights and obtain higher level of lighting power have been used.



ADVANCED AIR CONDITIONING SYSTEM

15 ventilation nozzles have been installed in the optimum areas in the cabin for the operator to work more comfortably. Thus, while a comfortable working environment is being provided to the operator, misting on windows is minimized.



CONTROL PANEL

The control panel has been designed ergonomically for controls to be used by the operator in a most proper way.





SIDE AND REAR CABIN WINDOWS

Alongside the rear window that can be easily opened monolithically and provides an important ease of use, opening door windows provide an ideal air circulation and a safe driving environment since it is not required to open the door during use.



COOL-BOX

It provides maintenance of current temperature of beverages put in it as well as that it cools them.

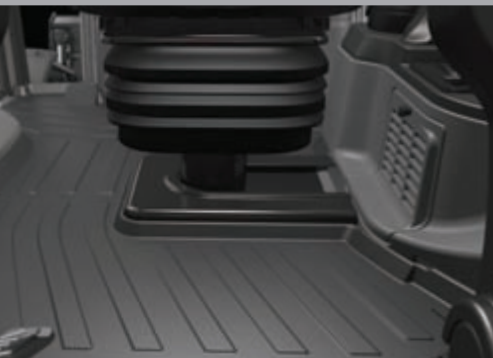

POOL TYPE MAT

Easy cleaning of cabin has been provided with pool-type mat.



DETACHABLE POCKETS

Washable pockets that have been located in various points in the SUPRA cabin provide the operator with multiple choices in putting materials.



PLASTIC FUEL TANK

While increased capacity of your fuel tank that is non-metallic and maintained with high level of safety precautions is prolonging the re-filling periods, it increases the time that you are on work.



FENDERS AND STEP LIGHTS

Fenders have been produced from break and impact-resistant special PDCPD material. LED step lights have been located on the fenders for operator to get in and out of the cab safely.



ROOF SHELF / SOUND SYSTEM

While the sound system with mp3 player as a standard equipment, is offering enjoyable environment to the operator, high-capacity roof shelves provide an ideal storage opportunity up to 10 kilos.



STORAGE BOXES

The pockets with different sizes and forms on the front and side walls of cabin provide ideal storage and container areas.

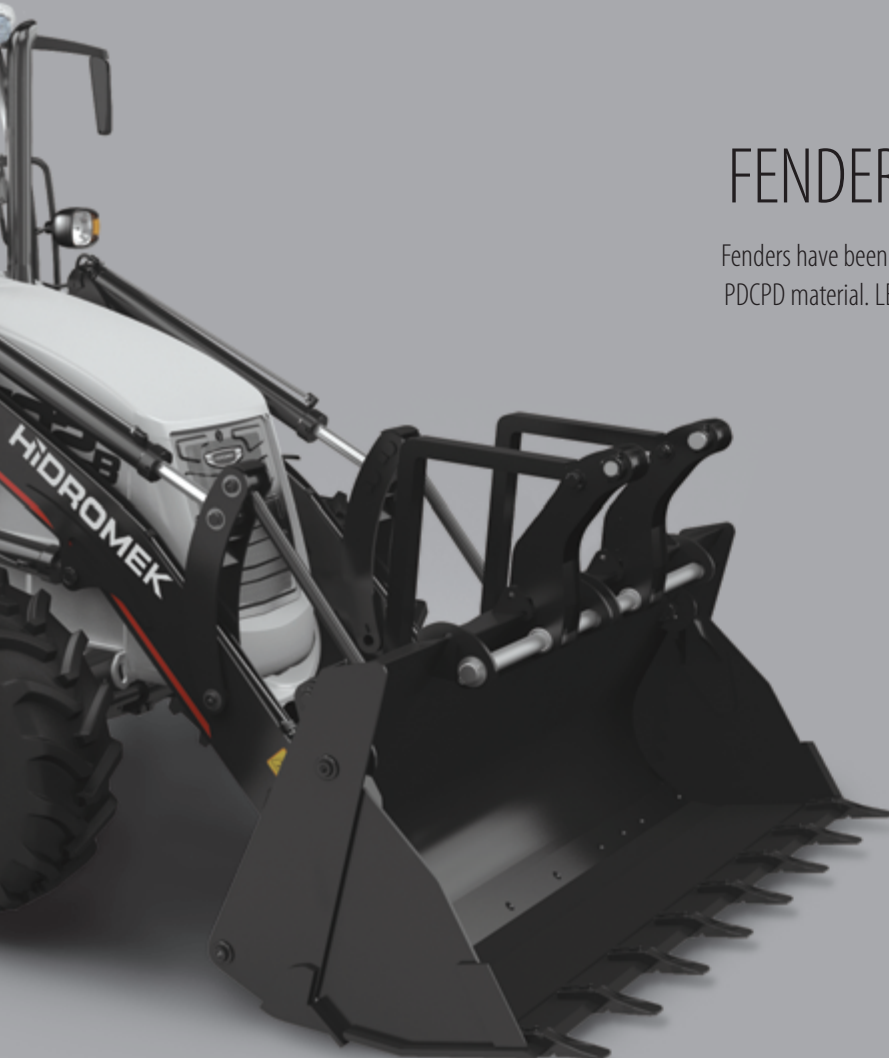





SmartLink

WITH SMARTLINK[®],
EVERYTHING ABOUT YOUR
MACHINE IS ON YOUR
DESKTOP OR IN YOUR
POCKET!

Do you wonder where your machine is or where it has worked for the day?

Answers of questions such as which day time periods and for how many hours it has worked can be reached easily now . . .

In the SUPRA Series backhoe loaders equipped with Hidromek SmartLink, there are special functions that can be reached with a single click such as many data and reporting services in relation with machine and its use for individual operators and fleets.

Hidromek SmartLink automatically receives the data in relation with the vehicle, GPS location of it and malfunction codes in vehicle terminals. Thus, it provides fast and effective service support.



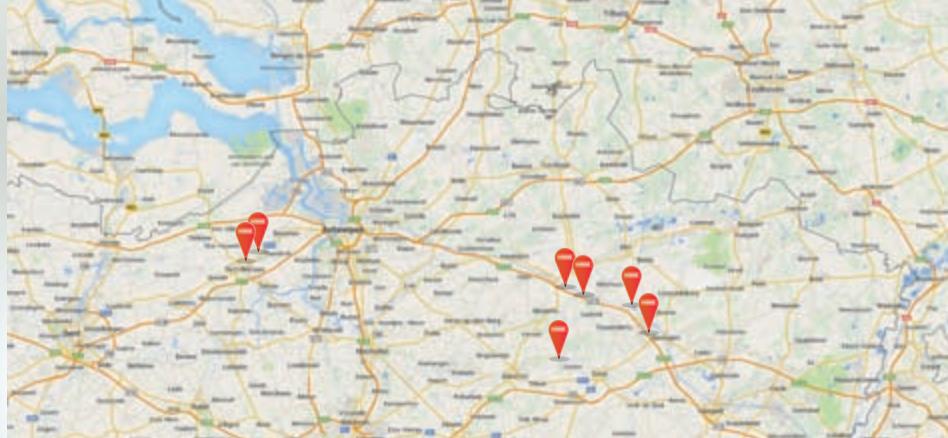

SUPRA

Where is my machine now?

How many hours are left for maintenance?

In which hours work has stopped in the day?

Do you need an assistant that draws up reports about the machines?



A close-up photograph of a construction worker's hands holding a white hard hat. The worker is wearing a blue and white plaid shirt and a high-visibility orange safety vest with two yellow reflective stripes. The worker's hands are wearing blue and white work gloves. The hard hat is white and has the brand name 'HIDROMEK' printed in black capital letters on its side. The background is a blurred construction site with a yellow truck and a metal structure.

HIDROMEK

SAFETY FIRST!

In our SUPRA Series machines developed with our engineering experience of 38 years, multidirectional safety precautions have been taken.

Windows that provide wide visual angle and LED working lights, 4 in front and 4 on behind, provide that the operator see outer environment as comfortable as possible while working.

For follow-up of data in relation with machine during drive without being distracted, there is LCD information screen on the front console.

The operator cabin has FOPS (Falling Object Protective Structure) and ROPS (Roll Over Protective Structure) certificates.

Safety belt integrated to the seat protects the position of operator on sloppy lands or during sudden moves and prevents him from losing handling.

In maintenance and access to the engine, safety has been provided with the boom lock integrated to the loader arm cylinder.

While the machine is in the stable operating position, possible accidents have been prevented with security valves on stabilizers.

Standard headlight provides that the machine is easily realized in traffic and worksite by the other vehicles.

Details such as wide side steps that have a special surface preventing sliding, LED step lighting and large cabin entrance have been thought for safety of the operator.

Hydraulic-driven excavator boom-lock that is controlled from a single button inside the operator cabin offers safe drive by providing stabilization of rear boom while driving.

BRAKE SAFETY

Accumulator used in the braking system prevents braking pedal from hardening even in the extraordinary situations such as there is no hydraulic support or a sudden stopping of engine and provides that the machine safely stops with a little pedal force as if the machine is working.

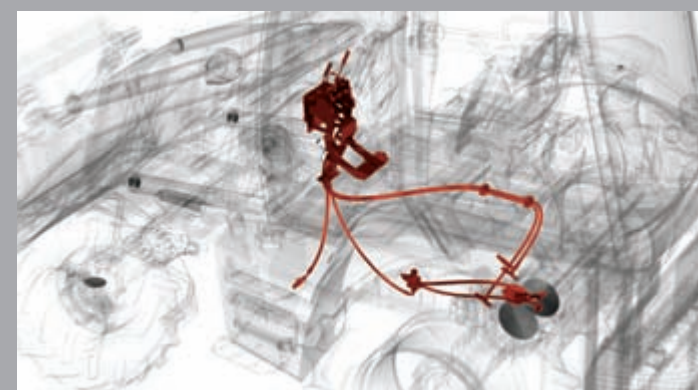

**HİDROMEK
SERVİS**

Mikrolu Servis Merkezi
444 6 465 (HİMEK)

Akkara Bölge Şubesi
0312 280 87 40

www.hidromek.com.tr



EASY MAINTAINENCE AND SERVICEABILITY

Front hood and side covers have been designed to minimize the time losses in maintenances and services offer multidirectional accessibility.

One of the most important characteristics of SUPRA Series that makes it more superior than its competitors is that hydraulic hoses are neat and their access is easy. This characteristic shortens the service periods and increases the working periods of machines.

The front grill can easily be opened with a key for access to accumulator and radiator group. This characteristic shortens the daily routine maintenance periods.

All of maintenance and service points have been situated to the places that are easy-to-access and also they are at the point where they can easily be reached from the ground level.

Owing to the sectional structure of main control valve, in case of damage, only the damaged part is changed and thus reduces the maintenance costs.

Hydraulic hose lines are protected for damages not to be exposed while working.

Fuse panel has been situated in a way that the operator can easily reach it for maintenance and serviceability.



SUPRA

SERIES



FIRST IN ITS CLASS WITH THE SUPRA SERIES!

For the first time in its class, LED working lighting system in SUPRA Series backhoe loaders are used as standard.

Importance of LED lighting system for operator during night shifts is great. While working whether with loader or excavator group in Supra Series, LED lightings on the cabin provides 2 times more lighting than the conventional. Also it provides the operator with clear night vision and working opportunity for long hours.



ENGINE

Emission Class	Stage IV (Tier 4 Final)
Brand, Model	PERKINS
Type	1204F-E44TAN Diesel Engine
Number of Cylinders	4 in line
Diameter x Stroke	105 x 127 mm
Displacement	4.400 cc
Max. Power	74.4 kW, 99.8 hp (2200 r/min)
Max. Torque	450 Nm (1400 r/min)
<ul style="list-style-type: none"> Starting kit for cold weather Self-cleaning chrome-plated turbo filter Diesel engine in which the latest technology is used, safe, requires a little maintenance, uses considerably low fuel, with high level of power and torque output, water-cooled, turbo-charged, intercooled. 	

HYDRAULIC SYSTEM

<ul style="list-style-type: none"> Closed type hydraulic system with variable displacement piston type pump, renewable flowsharing and valves with regeneration (Flowcharging) 	
Main Pump	2200 r/min
Flow	163 l/min
Pressure	250 bar
<ul style="list-style-type: none"> Antishock and anti-cavitation valves Backhoe joysticks designed especially for operator not to be tired, requiring minimum power and installed ergonomically Hyd. oil cooler ensuring problem free operation in a hot climate 10 micron oil filter 	

BRAKES

Service Brake	<ul style="list-style-type: none"> Self-adjusting, multi-disc oil bath type, hydraulically actuated brakes are located in the rear axle and act on 4 wheels
Park Brake	<ul style="list-style-type: none"> Hand-lever operated mechanical brake acts on the rear axle differential.

WEIGHT

Standard Machine Operation Weight	9.750 kg
-----------------------------------	----------

TRANSMISSION

- Heavy-duty type automatic transmission
- 6 forward 3 reverse gear
- Electric controlled 2 wheel drive or 4 wheel drive selection
- Torque convertor with 2,38:1 stalling rate
- A neutral circuit allows starting only when the control lever is in neutral position for safety.
- Transmission oil cooler
- Torque lock (Lock-up)

FILLING CAPACITIES

Engine Oil Pump	8,8	l
Engine Cooling System	22	l
Fuel Tank	150	l
Hydraulic Oil Tank	70	l
Transmission Oil	16	l
Front Axle Differential	9	l
Front Axle Hub Reducers	0,85x2	l
Rear Axle Differential	17	l
Ad blue	19	l

LOADER PERFORMANCE

6-in-1 Bucket Capacity	1.1 m ³
Max. Bucket Breakout Force	7930 kgf
Max. Loading Arm Breakout Force	7166 kgf
Lifting Capacity To Maximum Height	3561 kg
Maximum lifting capacity 7'4" (2.23 m)	4484 kg
Maximum lifting capacity 7' 8" (2.33 m)	4406 kg

BACKHOE PERFORMANCE

	TB (Extended)	TB (Retracted)
Rear Bucket Capacity	0.17 m ³	0.17 m ³
Max. Bucket Breakout Force	7240 kgf	7240 kgf
Max. Dipper Arm Breakout Force	3300 kgf	2536 kgf

DRIVING SPEEDS

In 2200 rpm		
1 st Gear	5.6	km/h
2 nd Gear	8.9	km/h
3 rd Gear	11.4	km/h
4 th Gear	18.1	km/h
5 th Gear	24.1	km/h
6 th Gear	40	km/h

AXLES

- Heavy-duty-type
- Total 16° oscillation in the front axle
- Planetary (4 gear) outboard type reduction gears
- Equipped with LSD (Limited Slip Differential) on the front axle and differential lock on the rear axle

ELECTRIC SYSTEM

Voltage	12 V
Battery	165 amperes/hour, heavy-duty type
Cranking Motor	3.2 kW
Alternator	100 Amp

STEERING

- Fully hydrostatic, load-sensitive
- Soft-Touch steering wheel

TIRES

- Front Tires 16/70-20 (12 layers)
- Rear Tires 16.9-28 (12 layers)
- Optional 18.4-26 (12 layers)

GENERAL CHARACTERISTICS

		Extended Dipper	
		Fully Extended	Fully Retracted
A	-Maximum digging depth (mm)	5627	4409
B	-Ground level to rear wheel centre (mm)	8183	7033
C	-Ground level to slew centre (mm)	6845	5695
D	-Loading distance (mm)	3106	2259
E	-Distance to machine central line (mm)	7456	6307
F	-Operating height (mm)	6611	5730
G	-Max. loader height (mm)	4735.5	3854
H	-Total kingpost travel (mm)	1187	
J	-Bucket rotation (°)	187	
K	-Shovel Width (mm)	2440	
L	-Rear frame width (mm)	2292	
M	-Dump height (mm)	2613	
N	-Load over height (mm)	3233	
O	-Pin height (mm)	3461	
P	-Front arm pin – bumper distance (mm)	587	
Q	-Grab lug – bumper distance (mm)	1494	
R	-Max. reach at full height (mm)	1532	
S	-Unloading distance (mm)	1060	
T	-Digging depth (mm)	183	
U	-Roll back at ground (°)	38	
V	-Dump angle (°)	47.3	
Y	-Front wheel centre to the ground (mm)	548.5	
Z	-Departure angle (°)	24.5	
W	-Rear wheel centre to ground (mm)	705	
X	-Distance between pin centre and ground (mm)	250	
AA	-Total travel length (mm)	6049.6	
BB	-Axle centreline distance (mm)	2190	
CC	-Slew centre to rear axle centre distance (mm)	1336	
DD	-Stabilizer feet clearance (mm)	401.5	
EE	-Kingpost clearance (mm)	536.8	
FF	-Steering wheel centre height (mm)	2050	
GG	-Cab roof height (mm)	2950	
HH	-Total travel clearance (mm)	3593	

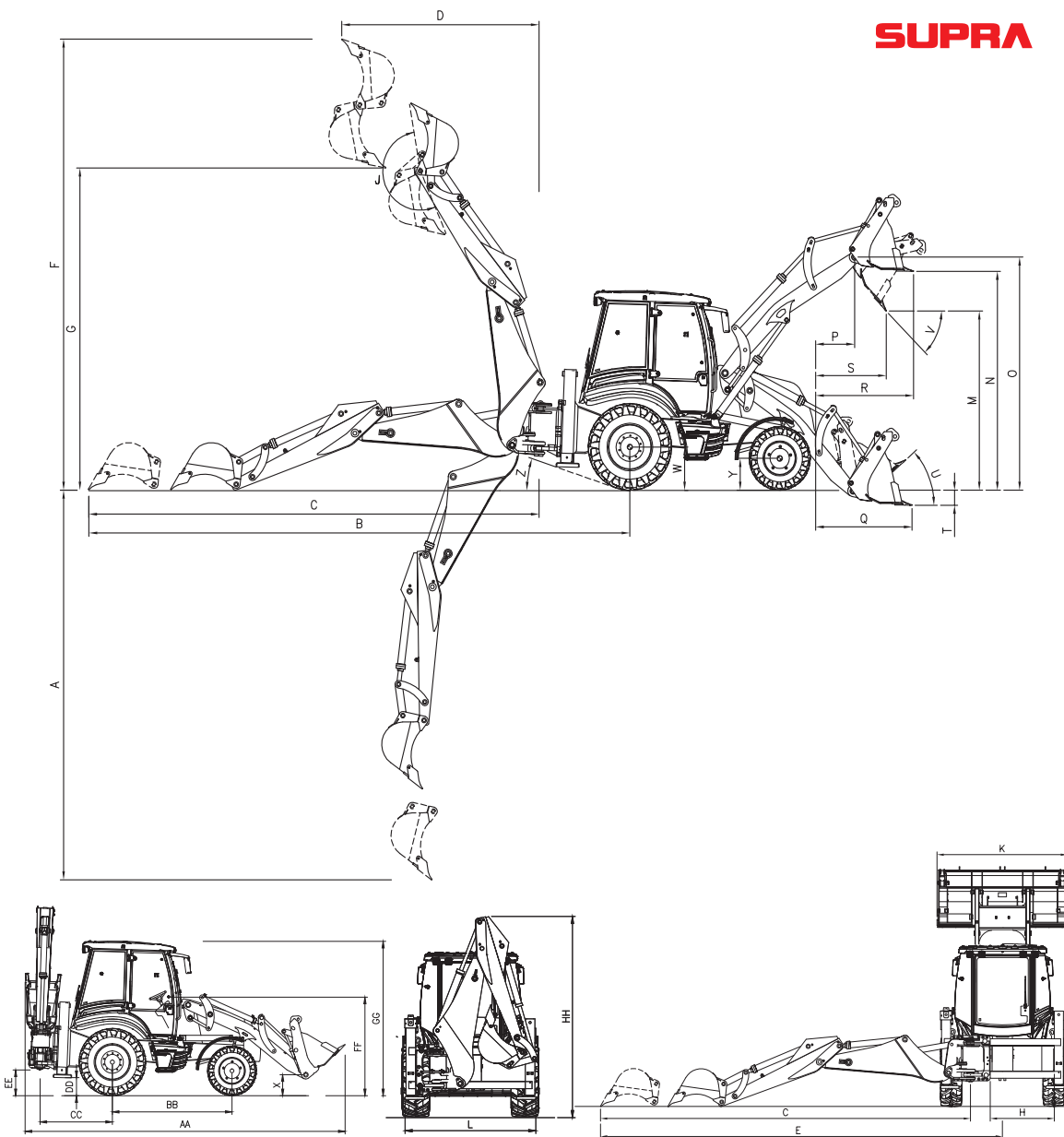

WARNING: HÍDROMEK reserves the right to change the values given in this catalogue and designs indicated without prior notification.

ENGINE

Emission Class	Stage IV (Tier 4 Final)
Brand, Model	PERKINS
Type	1204F-E44TAN Diesel Engine
Number of Cylinders	4 in line
Diameter x Stroke	105 x 127 mm
Displacement	4.400 cc
Max. Power	74.4 kW, 99.8 hp (2200 r/min)
Max. Torque	450 Nm (1400 r/min)
<ul style="list-style-type: none"> Starting kit for cold weather Self-cleaning chrome-plated turbo filter Diesel engine in which the latest technology is used, safe, requires a little maintenance, uses considerably low fuel, with high level of power and torque output, water-cooled, turbo-charged, intercooled. 	

HYDRAULIC SYSTEM

<ul style="list-style-type: none"> Closed type hydraulic system with variable displacement piston type pump, renewable flowsharing and valves with regeneration (Flowcharging) 	
Main Pump	2200 r/min
Flow	163 l/min
Pressure	250 bar
<ul style="list-style-type: none"> Antishock and anti-cavitation valves Backhoe joysticks designed especially for operator not to be tired, requiring minimum power and installed ergonomically Hyd. oil cooler ensuring problem free operation in a hot climate 10 micron oil filter 	

BRAKES

Service Brake	<ul style="list-style-type: none"> Self-adjusting, multi-disc oil bath type, hydraulically actuated brakes are located in the rear axle and act on 4 wheels
Park Brake	<ul style="list-style-type: none"> Hand-lever operated mechanical brake acts on the rear axle differential.

WEIGHT

Standard Machine Operation Weight	9.800 kg
-----------------------------------	----------

TRANSMISSION

<ul style="list-style-type: none"> Heavy-duty type automatic transmission 6 forward 3 reverse gear Electric controlled 2 wheel drive or 4 wheel drive selection Torque convertor with 2,38:1 stalling rate A neutral circuit allows starting only when the control lever is in neutral position for safety. Transmission oil cooler Torque lock (Lock-up)

FILLING CAPACITIES

Engine Oil Pump	8,8	l
Engine Cooling System	22	l
Fuel Tank	150	l
Hydraulic Oil Tank	70	l
Transmission Oil	16	l
Front Axle Differential	14	l
Front Axle Hub Reducers	1.7x2	l
Rear Axle Differential	16	l
Ad blue	17	l

LOADER PERFORMANCE

6-in-1 Bucket Capacity	1.2 m ³
Max. Bucket Breakout Force	7930 kgf
Max. Loading Arm Breakout Force	7166 kgf
Lifting Capacity To Maximum Height	3561 kg
Maximum lifting capacity 7'4" (2.23 m)	4484 kg
Maximum lifting capacity 7' 8" (2.33 m)	4406 kg

BACKHOE PERFORMANCE

	TB (Extended)	TB (Retracted)
Rear Bucket Capacity	0.17 m ³	0.17 m ³
Max. Bucket Breakout Force	7240 kgf	7240 kgf
Max. Dipper Arm Breakout Force	3300 kgf	2536 kgf

DRIVING SPEEDS

In 2200 rpm	
1 st Gear	6.1 km/h
2 nd Gear	9.8 km/h
3 rd Gear	13 km/h
4 th Gear	20.8 km/h
5 th Gear	26.3 km/h
6 th Gear	40 km/h

AXLES

<ul style="list-style-type: none"> Heavy-duty-type Total 16° oscillation in the front axle Planetary (4 gear) outboard type reduction gears Equipped with differential lock on the rear axle

ELECTRIC SYSTEM

Voltage	12V
Battery	165 amperes/hour, heavy-duty type
Cranking Motor	3.2 kW
Alternator	100 Amp

STEERING

<ul style="list-style-type: none"> Fully hydrostatic, load-sensitive Soft-Touch steering wheel

TIRES

Front / Rear Tires	16.9 – 28 (12 Ply rating)
--------------------	---------------------------

GENERAL CHARACTERISTICS

		Extended Dipper	
		Fully Extended	Fully Retracted
A	-Maximum digging depth (mm)	5703	4488
B	-Ground level to rear wheel centre (mm)	8244	7092
C	-Ground level to slew centre (mm)	6854	5703
D	-Loading distance (mm)	3087	2236
E	-Distance to machine central line (mm)	7452	6301
F	-Operating height (mm)	6552	5675
G	-Max. loader height (mm)	4679	3802
H	-Total kingpost travel (mm)	1187	
J	-Bucket rotation (°)	187	
K	-Shovel Width (mm)	2440	
L	-Rear frame width (mm)	2292	
M	-Dump height (mm)	2603	
N	-Load over height (mm)	3260	
O	-Pin height (mm)	3470	
P	-Front arm pin – bumper distance (mm)	480	
Q	-Grab lug – bumper distance (mm)	1463	
R	-Max. reach at full height (mm)	1458	
S	-Unloading distance (mm)	996	
T	-Digging depth (mm)	160	
U	-Roll back at ground (°)	43	
V	-Dump angle (°)	45	
Y	-Front wheel centre to the ground (mm)	650	
Z	-Departure angle (°)	20	
W	-Rear wheel centre to ground (mm)	625	
X	-Distance between pin centre and ground (mm)	250	
AA	-Total travel length (mm)	6090	
BB	-Axle centreline distance (mm)	2280	
CC	-Slew centre to rear axle centre distance (mm)	1395	
DD	-Stabilizer feet clearance (mm)	355	
EE	-Kingpost clearance (mm)	510	
FF	-Steering wheel centre height (mm)	2075	
GG	-Cab roof height (mm)	2985	
HH	-Total travel clearance (mm)	3600	

SUPRA

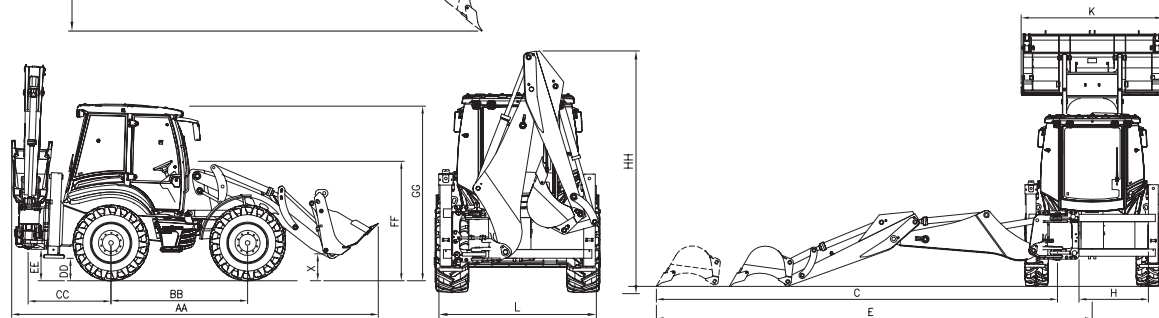
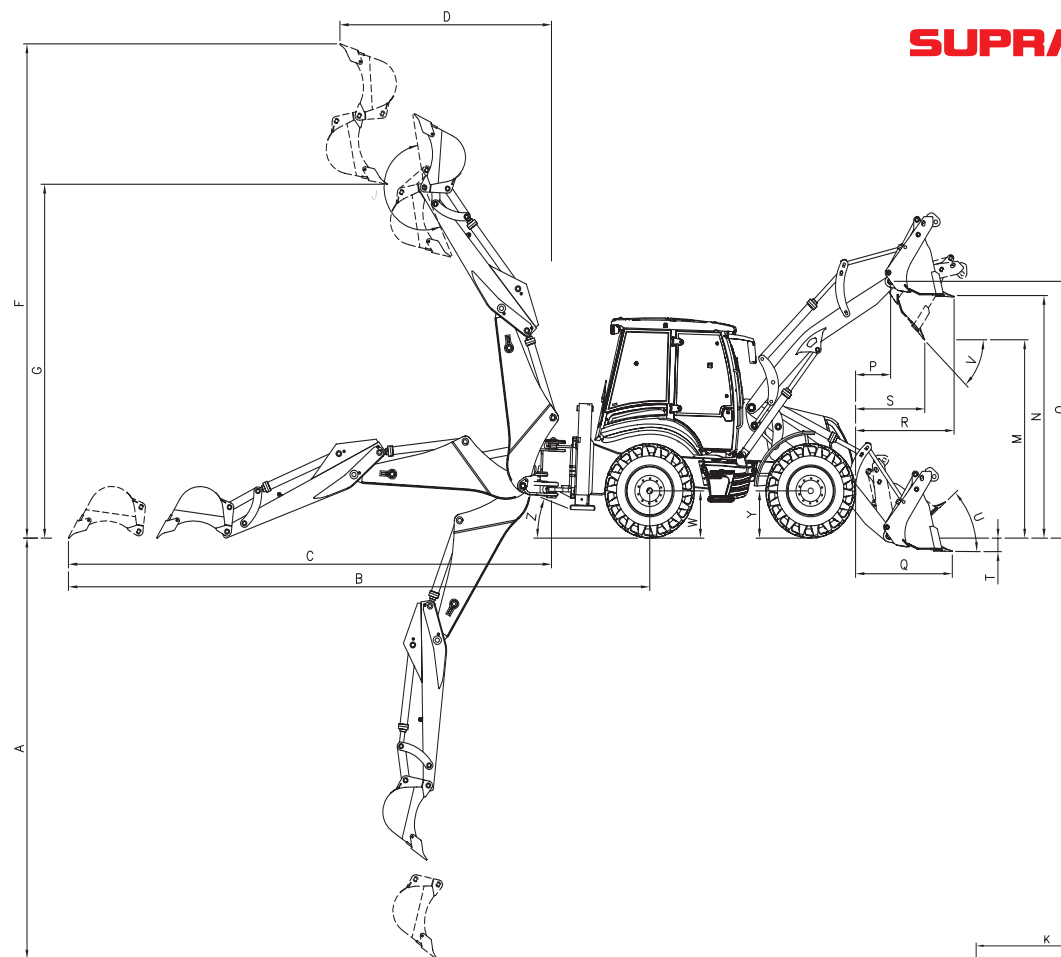

WARNING: HÍDROMEK reserves the right to change the values given in this catalogue and designs indicated without prior notification.



OPTIONAL ATTACHMENTS

SUPRA



Quick Coupler

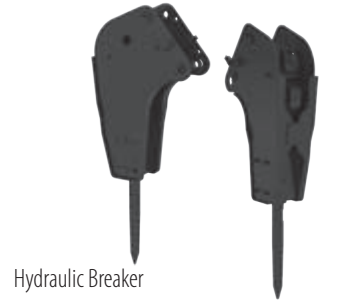

Hydraulic Breaker



Auger



Finishing Bucket

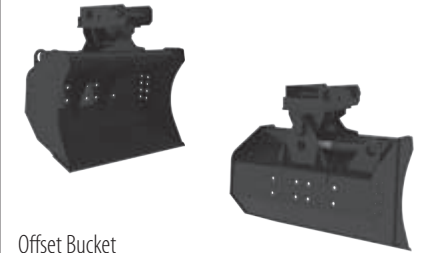

Offset Bucket



Clamshell Grap



Ripper

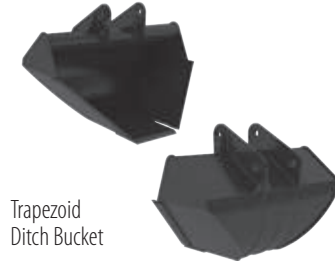

Trapezoid Ditch Bucket

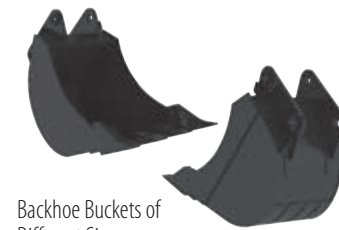

Backhoe Buckets of Different Sizes

Bucket Width (mm)	Bucket Capacity SAE (m3)		Empty Weight (+teeth) (kg)	Number of Teeth
	Heaped	Struck		
350	0.09	0.081	128.5	3
400	0.10	0.087	141.5	3
500	0.14	0.112	149.5	3
600	0.17	0.131	167	4
700	0.22	0.165	185	4
800	0.26	0.186	200.5	5
900	0.30	0.211	210.5	5

Backhoe Bucket Properties

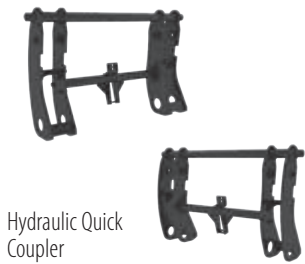

Hydraulic Quick Coupler



6-in-1 Bucket with Forklift Attachment



One Piece Bucket



6-in-1 Bucket with Quick Coupler

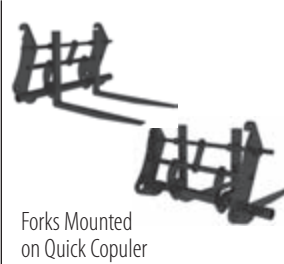

Forks Mounted on Quick Coupler

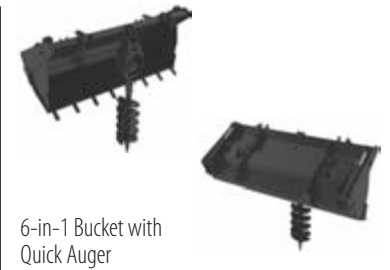

6-in-1 Bucket with Quick Auger

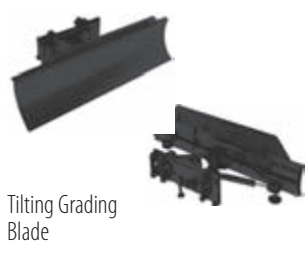

Tilting Grading Blade

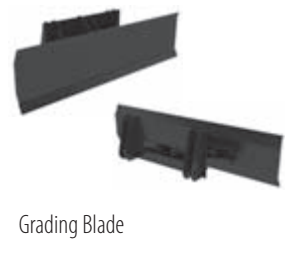

Grading Blade



Timber Bucket with Propulsion



Timber Bucket with 3 Clamps



Timber Bucket with 5 Clamps

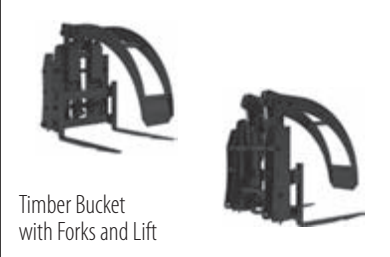

Timber Bucket with Forks and Lift

WARNING : Optional attachments and accessories standards offered with machines may vary depending on the countries. Consult your authorized seller for attachments and accessories.

NOT ONLY WITH OUR MACHINES, BUT ALSO WITH THE SERVICES WE PROVIDE, WE ARE DIFFERENT!



Expert Service

Our personnel who are experts in their subjects provide the opportunity of the highest quality and the fastest service with their high-end equipments.



Global Service Network

Hidromek that has global service network offers sale and service even in the various points of the world with hundreds of sale and service points abroad.



High Customer Satisfaction

A customer-oriented approach is adopted in all our operations in order to satisfy our customer at the highest level, add value their works and gain loyalty of them.

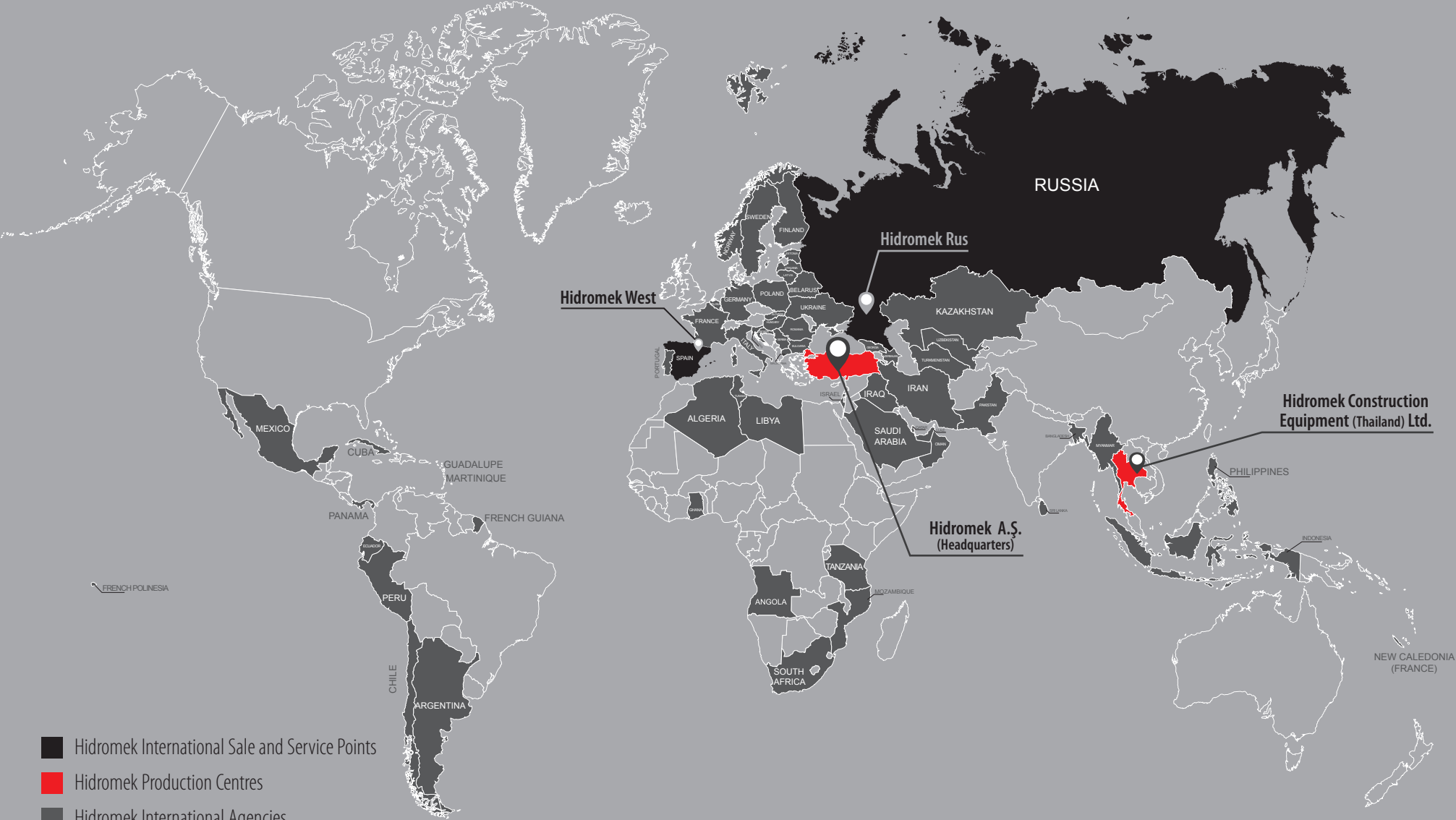

- Hidromek International Sale and Service Points
- Hidromek Production Centres
- Hidromek International Agencies

HIDROMEK®

ENG JULY 2017 / 010717

WARNING: Information and displays and equipment provided in this brochure are standard or optional depending on versions. Hidromek has the right to change values given and designs shown in this catalogue without giving a notification.

Head Office: Ayaş Yolu 25. Km 1. Organize Sanayi Bölgesi Osmanlı Caddesi, No: 1 06935 Sincan - ANKARA/TURKEY Telephone: +90 312 267 12 60 Fax: +90 312 267 12 39 Mail: export@hidromek.com.tr

Hidromek West: C/De la Maquina 14, Polígono Industrial El Regás, 08850 – Gavá (Barcelona) Tel : +34 93 638 84 65 Fax : +34 93 638 07 14 Mail: contact@hidromek.es

Hidromek Rus: 72, Zhivopisnaya str., village Oktyabrskiy, Krasnodar, Russia, 350032 Tel: +7 861 290 3007 Mail: Hidromekrus@hidromek.ru

Hidromek Construction Equipment (Thailand) Ltd.: Amata Nakorn Industrial Estate Phase 7, 700/669 Moo 1, T.Phanthong A.Phanthong, Chonburi 20160, Thailand Tel : +66 38 447 349 Fax : +66 38 447 355